

2.- ABASTECIMIENTO A CERREDO 1

Titular:		Ayuntamiento de DEGAÑA						Gestor: Ayuntamiento de DEGAÑA									
Nº P.M.	Entidad singular	Población (Nomenclator 2003-SADEI)					Depósito	Captación	Tratamiento		Nº Análisis			Nº determinaciones cloro residual libre			
		De derecho	Abastecida	Controlada E.S.	Controlada P.M.	% Controlada P.M.			ETAP	CI	Tot	A	NA	Tot	C	H	A
3	Cerredo 1 Los Tachos	986	758	758	758	76,8	VALLE DE LA CORZA VALLE DE LA CORZA	Manantial La Fuentecona (1) Manantial La Fuentecona (1)			3	3	0	3	0	0	3
Total		986	758	758	758	76,8					3	3	0	3	0	0	3

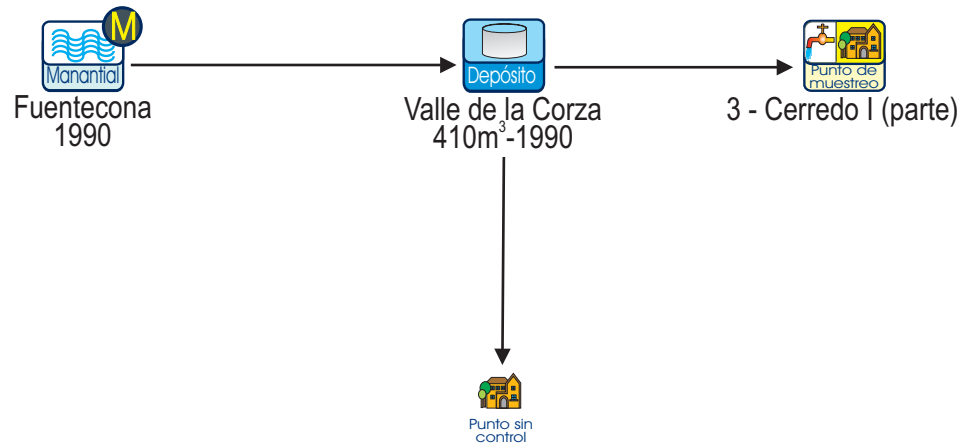

Símbolos empleados

Procedencia



Almacenamiento y distribución



Tratamiento

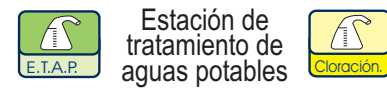

Abastecimiento y Control



Agua sin tratamiento
 Agua tratada
 Agua bombeada

3.- ABASTECIMIENTO A CERREDO 2

Titular:		Ayuntamiento de DEGAÑA						Gestor: Ayuntamiento de DEGAÑA									
Nº P.M.	Entidad singular	Población (Nomenclator 2003-SADEI)					Depósito	Captación	Tratamiento		Nº Análisis			Nº determinaciones cloro residual libre			
		De derecho	Abastecida	Controlada E.S.	Controlada P.M.	% Controlada P.M.			ETAP	CI	Tot	A	NA	Tot	C	H	A
4	Cerredo 2	986*	228	228	228	15,7	COLOMINAS (1)	Manantial La Candaniecha (3)			3	3	0	3	0	0	3
Total		986*	228	228	228	15,7					3	3	0	3	0	0	3

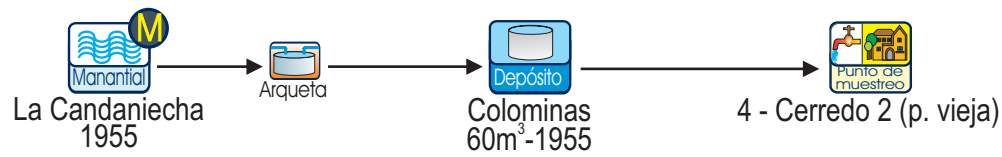

Símbolos empleados

Procedencia



Almacenamiento y distribución



Tratamiento



Estación de tratamiento de aguas potables

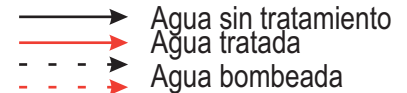

Abastecimiento y Control



1.- ABASTECIMIENTO GENERAL A DEGAÑA

Titular:		Ayuntamiento de DEGAÑA						Responsable: Ayuntamiento de DEGAÑA									
N° P.M.	Entidad singular	Población (Nomenclator 2003-SADEI)					Depósito	Captación	Tratamiento		N° Análisis			N° determinaciones cloro residual libre			
		De derecho	Abastecida	Controlada E.S.	Controlada P.M.	% Controlada P.M.			ETAP	CI	Tot	A	NA	Tot	C	H	A
1	Degaña 1 (parte)	269	179	179	179	12,3	NUEVO (2)	Manantial Calamin (3) y Manantial Macareno			3	3	0	3	0	0	3
2	Degaña 2 (parte)	269*	90	90	90	6,2	VIEJO (2)	Manantial Calamin (3) y Manantial Prao Felipe (3)			3	3	0	3	0	0	3
Total		269	269	269	269	19					6	6	0	6	0	0	6

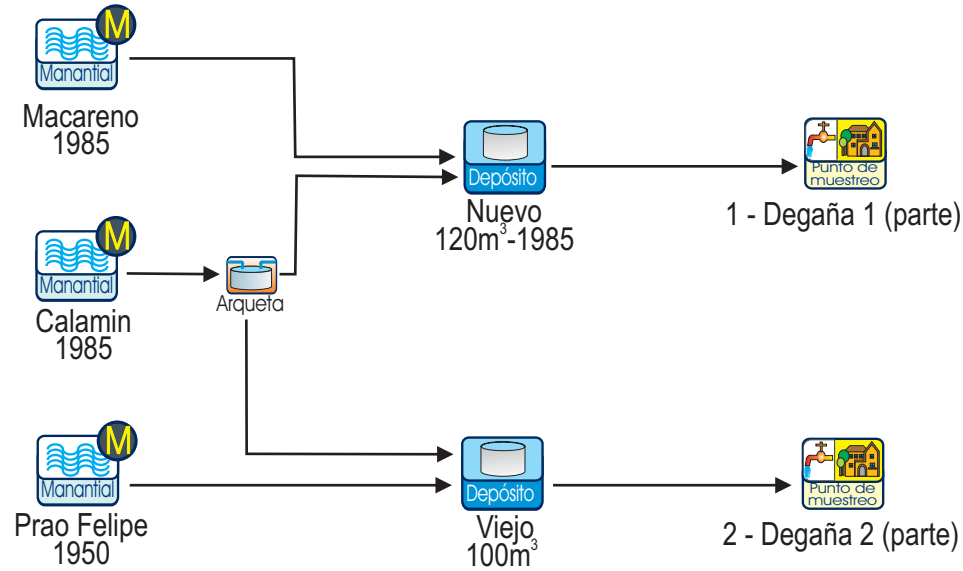

Símbolos empleados

Procedencia						Tratamiento		Estación de tratamiento de aguas potables		Agua sin tratamiento Agua tratada Agua bombeada
Almacenamiento y distribución					Abastecimiento y Control				Fuente pública	

4.- ABASTECIMIENTO A REBOLLAR

Titular:		Ayuntamiento de DEGAÑA						Gestor: Ayuntamiento de DEGAÑA									
Nº P.M.	Entidad singular	Población (Nomenclator 2003-SADEI)					Depósito	Captación	Tratamiento		Nº Análisis			Nº determinaciones cloro residual libre			
		De derecho	Abastecida	Controlada E.S.	Controlada P.M.	% Controlada P.M.			ETAP	CI	Tot	A	NA	Tot	C	H	A
5	Rebollar	101	101	101	101	6,9	LA MATA (3)	Manantial Fuente del Abedul (2)			3	3	0	3	0	0	3
Total		101	101	101	101	6,9					3	3	0	3	0	0	3

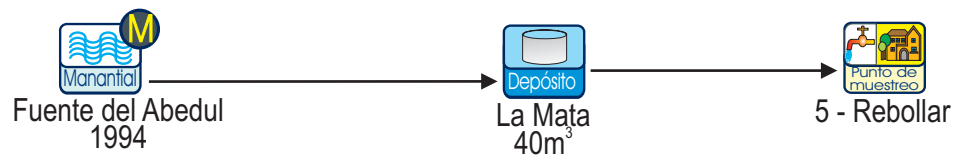

Símbolos empleados

Procedencia



Tratamiento

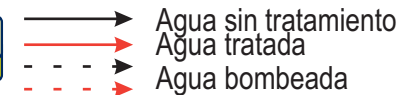

Almacenamiento y distribución



Abastecimiento y Control

